

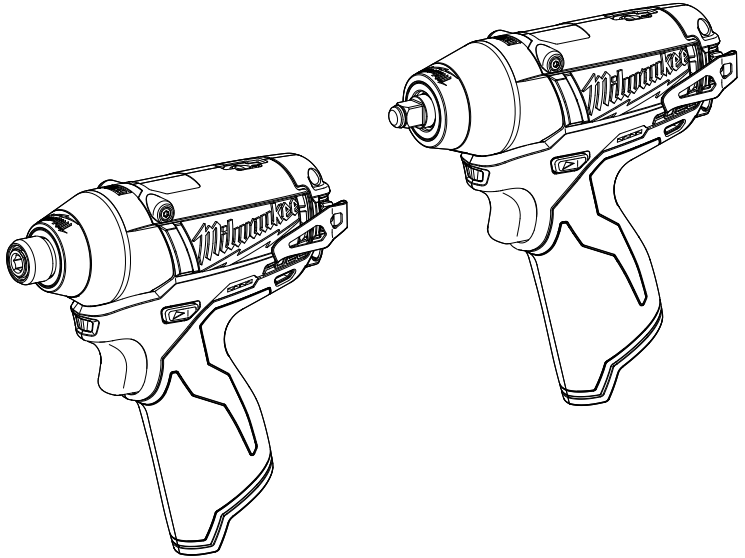

**DRAFT**

**OPERATOR'S MANUAL**

Cat. No.  
M12 CID  
M12 CIW%&  
A%&7 =K ' , ' ,



**M12™ FUEL™ 1/4" Hex Impact Driver, 3/8" & 1/2" IMPACT WRENCH**

**TO REDUCE THE RISK OF INJURY, USER MUST READ AND UNDERSTAND OPERATOR'S MANUAL.**



## GENERAL POWER TOOL SAFETY WARNINGS



### **WARNING READ ALL SAFETY WARNINGS AND ALL INSTRUCTIONS.**

Failure to follow the warnings and instructions may result in electric shock, fire and/or serious injury. **Save all warnings and instructions for future reference.** The term "power tool" in the warnings refers to your mains-operated (corded) power tool or battery-operated (cordless) power tool.

### **WORK AREA SAFETY**

- **Keep work area clean and well lit.** Cluttered or dark areas invite accidents.
- **Do not operate power tools in explosive atmospheres, such as in the presence of flammable liquids, gases or dust.** Power tools create sparks which may ignite the dust or fumes.
- **Keep children and bystanders away while operating a power tool.** Distractions can cause you to lose control.

### **ELECTRICAL SAFETY**

- **Power tool plugs must match the outlet. Never modify the plug in any way. Do not use any adapter plugs with earthed (grounded) power tools.** Unmodified plugs and matching outlets will reduce risk of electric shock.
- **Avoid body contact with earthed or grounded surfaces such as pipes, radiators, ranges and refrigerators.** There is an increased risk of electric shock if your body is earthed or grounded.
- **Do not expose power tools to rain or wet conditions.** Water entering a power tool will increase the risk of electric shock.
- **Do not abuse the cord. Never use the cord for carrying, pulling or unplugging the power tool. Keep cord away from heat, oil, sharp edges or moving parts.** Damaged or entangled cords increase the risk of electric shock.
- **When operating a power tool outdoors, use an extension cord suitable for outdoor use.** Use of a cord suitable for outdoor use reduces the risk of electric shock.
- **If operating a power tool in a damp location is unavoidable, use a residual current device (RCD) protected supply.** Use of an RCD reduces the risk of electric shock.

### **PERSONAL SAFETY**

- **Stay alert, watch what you are doing and use common sense when operating a power tool. Do not use a power tool while you are tired or under the influence of drugs, alcohol or medication.** A moment of inattention while operating power tools may result in serious personal injury.
- **Use personal protective equipment. Always wear eye protection.** Protective equipment such as dust mask, non-skid safety shoes, hard hat, or hearing protection used for appropriate conditions will reduce personal injuries.
- **Prevent unintentional starting. Ensure the switch is in the off-position before connecting to power source and/or battery pack, picking up or carrying the tool.** Carrying power tools with your finger on the switch or energising power tools that have the switch on invites accidents.
- **Remove any adjusting key or wrench before turning the power tool on.** A wrench or a key left

attached to a rotating part of the power tool may result in personal injury.

- **Do not overreach. Keep proper footing and balance at all times.** This enables better control of the power tool in unexpected situations.
- **Dress properly. Do not wear loose clothing or jewellery. Keep your hair, clothing and gloves away from moving parts.** Loose clothes, jewellery or long hair can be caught in moving parts.
- **If devices are provided for the connection of dust extraction and collection facilities, ensure these are connected and properly used.** Use of dust collection can reduce dust-related hazards.

### **POWER TOOL USE AND CARE**

- **Do not force the power tool. Use the correct power tool for your application.** The correct power tool will do the job better and safer at the rate for which it was designed.
- **Do not use the power tool if the switch does not turn it on and off.** Any power tool that cannot be controlled with the switch is dangerous and must be repaired.
- **Disconnect the plug from the power source and/or the battery pack from the power tool before making any adjustments, changing accessories, or storing power tools.** Such preventive safety measures reduce the risk of starting the power tool accidentally.
- **Store idle power tools out of the reach of children and do not allow persons unfamiliar with the power tool or these instructions to operate the power tool.** Power tools are dangerous in the hands of untrained users.
- **Maintain power tools. Check for misalignment or binding of moving parts, breakage of parts and any other condition that may affect the power tool's operation. If damaged, have the power tool repaired before use.** Many accidents are caused by poorly maintained power tools.
- **Keep cutting tools sharp and clean.** Properly maintained cutting tools with sharp cutting edges are less likely to bind and are easier to control.
- **Use the power tool, accessories and tool bits etc., in accordance with these instructions, taking into account the working conditions and the work to be performed.** Use of the power tool for operations different from those intended could result in a hazardous situation.

### **BATTERY TOOL USE AND CARE**

- **Recharge only with the charger specified by the manufacturer.** A charger that is suitable for one type of battery pack may create a risk of fire when used with another battery pack.
- **Use power tools only with specifically designated battery packs.** Use of any other battery packs may create a risk of injury and fire.

- When battery pack is not in use, keep it away from other metal objects like paper clips, coins, keys, nails, screws, or other small metal objects that can make a connection from one terminal to another. Shorting the battery terminals together may cause burns or a fire.
- Under abusive conditions, liquid may be ejected from the battery; avoid contact. If contact accidentally occurs, flush with water. If liquid contacts eyes, additionally seek medical help. Liquid ejected from the battery may cause irritation or burns.

### SERVICE

- Have your power tool serviced by a qualified repair person using only identical replacement parts. This will ensure that the safety of the power tool is maintained.

### SPECIFIC SAFETY RULES

- Hold power tool by insulated gripping surfaces, when performing an operation where the fastener may contact hidden wiring. Fasteners contacting a "live" wire may make exposed metal parts of the power tool "live" and could give the operator an electric shock.
- Wear ear protection when impact drilling. Exposure to noise can cause hearing loss.
- Use only sockets and other accessories specifically designed for use on impact wrenches and drivers. Other sockets and accessories might shatter or break causing injury.
- Maintain labels and nameplates. These carry important information. If unreadable or missing, contact a MILWAUKEE service facility for replacement.
- WARNING: Some dust created by power sanding, sawing, grinding, drilling, and other construction activities contains chemicals known to cause cancer, birth defects or other reproductive harm. Some examples of these chemicals are:
  - lead from lead-based paint
  - crystalline silica from bricks and cement and other masonry products, and
  - arsenic and chromium from chemically-treated lumber.
 Your risk from these exposures varies, depending on how often you do this type of work. To reduce your exposure to these chemicals: work in a well ventilated area, and work with approved safety equipment, such as those dust masks that are specially designed to filter out microscopic particles.

### SYMBOLGY

	Volts
	Direct Current
$n_{xxxx}/min.$	Impacts per Minute Under Load (IPM)
$n_0 xxxxmin.^{-1}$	No Load Revolutions per Minute (RPM)
	Underwriters Laboratories, Inc. United States and Canada

### SPECIFICATIONS

Cat. No.	Volts DC	RPM		IPM	
		Mode	Speed	Mode	Impacts
M12 CID	12	1	0 - 1200	1	0 - 2700
		2	0 - 2650	2	0 - 3550
M12 CIW12	12	1	0 - 1500	1	0 - 2650
		2	0 - 2650	2	0 - 3500
M12 CIW38	12	1	0 - 1200	1	0 - 2650
		2	0 - 2650	2	0 - 3500

### FUNCTIONAL DESCRIPTION

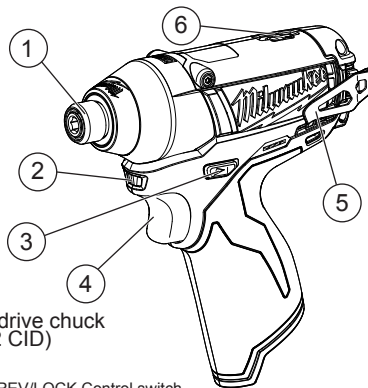

1. Hex drive chuck (M12 CID)
2. LED
3. FWD/REV/LOCK Control switch
4. Trigger
5. Belt clip
6. 2-Mode drive control
7. Square drive shank (M12 CIW38 & M12 CIW12)

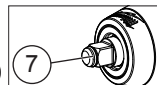

## ASSEMBLY

**WARNING** Recharge only with the charger specified for the battery. For specific charging instructions, read the operator's manual supplied with your charger and battery.

### Inserting/Removing the Battery

To **remove** the battery, push in the release buttons and pull the battery pack away from the tool.

To **insert** the battery, slide the pack into the body of the tool. Make sure it latches securely into place.

**WARNING** Always remove battery pack before changing or removing accessories. Only use accessories specifically recommended for this tool. Others may be hazardous.

**WARNING** Use only sockets and other accessories specifically designed for use on impact wrenches and drivers. Other sockets and accessories might shatter or break causing injury.

### Attaching and Removing Accessories

#### Square drive shank (Model No. M12 CIW38 & M12 CIW12)

These impact wrenches are intended only for use with sockets designed for impact wrenches that have a 3/8" or 1/2" (Model No. M12 CIW38 & M12 CIW12) square drive. Other sockets could shatter or break, causing injury.

1. To attach a socket or other accessory, align the accessory with the drive shank and push it firmly over the retaining ring.
2. To remove the accessory, pull the accessory off the drive shank.

#### Hex drive chuck (Model No. M12 CID)

This driver is intended for use with drill and driver bits with a 1/4" hex shank and ball detent recess.

1. To attach an accessory, press the shank into the hex drive chuck.
2. To remove the accessory, pull out the ring and remove the accessory. Release the ring.

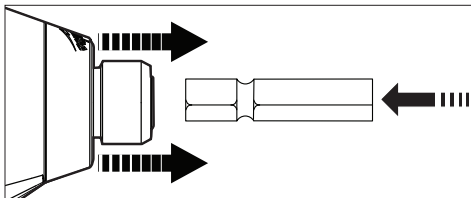

## OPERATION

**WARNING** Always remove battery pack before changing or removing accessories. Only use accessories specifically recommended for this tool. Others may be hazardous.

**WARNING** To reduce the risk of injury, wear safety goggles or glasses with side shields.

### Fuel Gauge

To determine the amount of charge left in the battery, pull the trigger. The Fuel Gauge will light up for 2-3 seconds.

To signal the end of charge, 1 light on the fuel gauge will flash for 2-3 seconds.

### Using the Drive Control

The drive control button is used to adjust the torque, rotation speed (RPM), and impact speed (IPM) for the application (see *Specifications* chart for RPM and IPM).

To select the drive control mode:

1. Pull and release the trigger to turn on the tool. The current mode indicator is lit.
2. Press the drive control button to cycle through the 2 modes. When the desired mode indicator is lit, begin work.

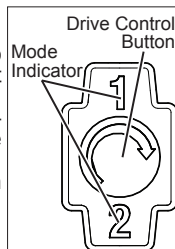

### Using the Control Switch

The control switch may be set to three positions: forward, reverse and lock. Due to a lockout mechanism, the control switch can only be adjusted when the motor to come to a complete stop before using the control switch.

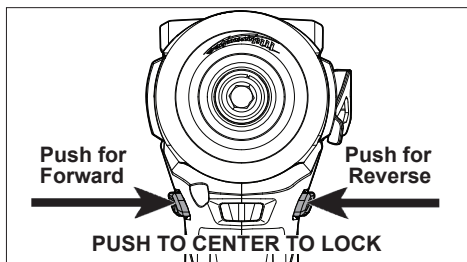

1. For **forward** (clockwise) rotation, push the control switch in the direction shown. Check the direction of rotation before use.
2. For **reverse** (counterclockwise) rotation, push the control switch in the direction shown. Check the direction of rotation before use.
3. To **lock** the trigger, push the control switch to the center position. The trigger will not work when the control switch is in the locked position. Always remove the battery pack before performing maintenance, changing accessories, storing the tool and any time the tool is not in use.

### Starting, Stopping and Controlling Speed

These tools may be operated at any speed from 0 to full speed.

1. To **start** the tool, pull the trigger.  
NOTE: An LED is turned on when the trigger is pulled.
2. To **vary** the driving speed, simply increase or decrease pressure on the trigger. The further the trigger is pulled, the greater the speed.
3. To **stop** the tool, release the trigger and the electric brake stops the tool instantly.

### Impacting Techniques

The longer a bolt, screw, or nut is impacted, the tighter it will become. To help prevent damaging the fasteners or workpieces, avoid excessive impacting. Be particularly careful when impacting smaller fasteners because they require less impacting to reach optimum torque.

Practice with various fasteners, noting the length of time required to reach the desired torque. Check the tightness with a hand-torque wrench. If the fasteners are too tight, reduce the impacting time. If they are not tight enough, increase the impacting time.

Oil, dirt, rust or other matter on the threads or under the head of the fastener affects the degree of tightness.

The torque required to loosen a fastener averages 75% to 80% of the tightening torque, depending on the condition of the contacting surfaces.

On light gasket jobs, run each fastener down to a relatively light torque and use a hand torque wrench for final tightening.

## MAINTENANCE

 **WARNING** To reduce the risk of injury, always unplug the charger and remove the battery pack from the charger or tool before performing any maintenance. Never disassemble the tool, battery pack or charger. Contact a **MILWAUKEE** service facility for **ALL** repairs.

### Maintaining Tool

Keep your tool, battery pack and charger in good repair by adopting a regular maintenance program. After six months to one year, depending on use, return the tool, battery pack and charger to A **MILWAUKEE** service facility for:

- Lubrication
- Mechanical inspection and cleaning (gears, spindles, bearings, housing, etc.)
- Electrical inspection (battery pack, charger, motor)
- Testing to assure proper mechanical and electrical operation

If the tool does not start or operate at full power with a fully charged battery pack, clean the contacts on the battery pack. If the tool still does not work properly, return the tool, charger and battery pack, to a **MILWAUKEE** service facility for repairs.

 **WARNING** To reduce the risk of personal injury and damage, never immerse your tool, battery pack or charger in liquid or allow a liquid to flow inside them.

### Cleaning

Clean dust and debris from charger and tool vents. Keep tool handles clean, dry and free of oil or grease. Use only mild soap and a damp cloth to clean the tool, battery pack and charger since certain cleaning agents and solvents are harmful to plastics and other insulated parts. Some of these include turpentine, lacquer thinner, paint thinner, chlorinated cleaning solvents, ammonia and household detergents containing ammonia. Never use flammable or combustible solvents around tools.

### Repairs

For repairs, return the tool, battery pack and charger to the nearest service center, please visit [www.milwaukeetools.com.au](http://www.milwaukeetools.com.au) / [www.milwaukeetools.co.nz](http://www.milwaukeetools.co.nz) or contact our customer service centre (Australia Toll Free Telephone Number 1300 361 505) (New Zealand Toll Free Telephone Number 0800 279 624).

## ACCESSORIES

 **WARNING** Always remove battery pack before changing or removing accessories. Only use accessories specifically recommended for this tool. Others may be hazardous.

For a complete listing of accessories, refer to your **MILWAUKEE** Electric Tool catalog or go online to [www.milwaukeetools.com.au](http://www.milwaukeetools.com.au) / [www.milwaukeetools.co.nz](http://www.milwaukeetools.co.nz). To obtain a catalog, contact your local distributor or service center.

**Milwaukee Electric Tool Corporation**

13135 West Lisbon Road, Brookfield, Wisconsin U.S.A. 53005

**Milwaukee Electric Tool Corporation (Australia)**

Techtronic Industries (Australia) Pty. Ltd.  
Doncaster, Victoria, Australia, 3108

**Milwaukee Electric Tool Corporation (New Zealand)**

Techtronic Industries (New Zealand) Pty. Ltd.  
Mangere, Auckland, New Zealand, 2022

Professionally made in China for Milwaukee Electric Tool Corporation